

219 Series - Industrial Relays

DPDT, up to 6PST, 10 Amps



Versatile. Rugged. Proven. These are but a few words used by customers to describe the 219 series. When long life and cost of down time / service are important the 219 solves the problem. It's a standard throughout industrial applications which many other relays are measured against. Capable of up to four poles double throw or six poles single throw. Contact arrangements are easily customized for special applications. NUCLEAR versions are available that utilize special platings and materials to minimize wear. All 219s are built with materials that meet the UL 94-V0 requirements.

GENERAL SPECIFICATIONS (@ 25° C)

Contacts:

Contact Configuration	Up to 4PDT or 6PST
Contact Material	Silver Alloy-Gold Diffused
Contact Rating	
120 / 240VAC Resistive	*10 Amp / 5 Amp
28VDC Resistive	*10 Amp
Contact Resistance, Initial	50 milliohms max @ 6vdc

Coil:

Coils Available	AC and DC
Nominal Coil Power	AC 5VA DC 1.8-2.5W
Input Voltage Tolerance - AC	85% to 110% of nominal
Input Voltage Tolerance - DC	80% to 110% of nominal
Drop-out voltage	10% of nominal
Duty	Continuous

Timing:

Operate Time (max)	25 mS
Release Time (max)	20 mS

Dielectric Strength:

Across Open Contacts	500Vrms
Between mutually insulated point	1500Vrms
Insulation resistance	1,000 Mohms min @ 500VDC

Temperature:

Operating	AC = -20 to 60°C (-4 to 140°F) DC = -20 to 70°C (-4 to 158°F)
Storage	-40 to 105°C (-40 to 221°F)

Life Expectancy:

Electrical (full load)	100,000
Mechanical (no load)	10,000,000

Miscellaneous:

Mounting Position	Any
Enclosure	Clear Polycarbonate
Weight	8.5oz (241 grams)
Mating socket	12 PIN: 27390 (D)
(UL Listed when used)	14 PIN: 33377 (D)
	(D) is option for DIN Rail Mount, but is not UL Listed

*30A maximum per relay with UL Rating



General Purpose Relays

Ordering Code **219** **XBX** **PL** **-24VDC**

Series
219

Contact Arrangement

- XBX (DPDT)
- ABA (1 Pole N.O. + DPDT + 1 Pole N.C.)
- BBX (2 Pole NO & DPDT)
- XDX (4PDT)
- FXX (6 Pole-NO)
- DXB (4 Pole - NO & 2 Pole-NC)

Optional Features

- Permanent Magnet Blowout - CODE 69
- Polycarbonate covers - CODE P
- Indicator Lamp - CODE L
- Manual Actuator - CODE M
- Bifurcated Contacts - CODE 33
- Diode Suppression - CODE V

Coil Voltage

- AC: 12, 24, 120, 240, (Add VAC)
- DC: 6, 12, 24/28, 32, 48, 115/125, 250 (Add VDC)

Coil voltages and frequencies must be specified

UL Contact Load Ratings Table

Contact Configuration	Current	Load Voltage	Load Frequency Voltage	Type of Load
All Styles EXCEPT Code 33	10 Amp	120 VAC	50/60Hz	RESISTIVE
	5 Amp	240 VAC	50/60Hz	RESISTIVE
	10 Amp	28 VDC	DC	RESISTIVE
	0.5 Amp	125 VDC	DC	RESISTIVE
	3 Amp	120 VAC	50/60Hz	INDUCTIVE
	1 Amp	240 VAC	50/60Hz	INDUCTIVE
	3 Amp	28 VDC	DC	INDUCTIVE
	0.1 Amp	125 VDC	DC	INDUCTIVE

Suffix "69" with blowout magnet for DC switching (NOT UL OR CSA)

Contact Configuration	Current	Load Voltage	Load Frequency Voltage	Type of Load
Single Make and Double Make	1.5 Amp	125 VDC	DC	RESISTIVE
	4 Amp	125 VDC	DC	RESISTIVE
	0.5 Amp	250 VDC	DC	RESISTIVE
	1.5 Amp	250 VDC	DC	RESISTIVE
	0.5 Amp	125 VDC	DC	INDUCTIVE
	1.5 Amp	125 VDC	DC	INDUCTIVE
	150 mA	250 VDC	DC	INDUCTIVE
	0.5 Amp	250 VDC	DC	INDUCTIVE

Note:

Use Code "33" for switching low level current below 50mA.

Use Code "69" for switching DC contact voltages above 40VDC.

219 Coil Specifications

AC Coils, 50/60HZ					DC Coils			
Nominal voltage	Resistance ohms ±10%	Milliamperes		Impedance ohms	Nominal voltage	Resistance ohms ±10%	Milliamperes	
		Cold	Hot				Cold	Hot
6	1.1	1500	840	7.2	6	15.5	385	304
12	4.2	750	410	27	12	63.5	189	147
24	15.5	375	200	120	24 /28*	250	96	77
120	540	75	40	2,700	32	375	86	62
240	2100	32	17	13,400	37.5	375	100	80
					48	975	49	39
					115/125*	6200	20	16
					250	27777	9	7

*Note: Stock 24VDC and 115VDC relays have nameplates stamped 24/28VDC and 115/125VDC respectively. These relays operate at 80% of the lower voltages and operate within allowable temperature rises at higher voltages.

219 Series - Industrial Relays

DPDT, Up To 6PST, 10 Amps

Outline Dimensions

Dimensions Shown in inches & (millimeters)

12 Pin Plug-in

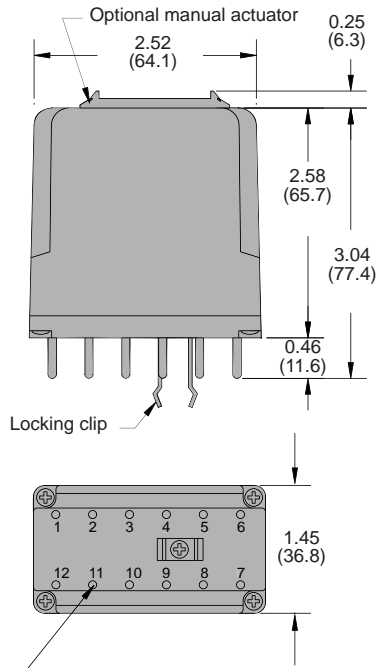

.10 x .43 (2.5 x 11.0) DIA. Typical of all pin dimensions

14 Pin Plug-in

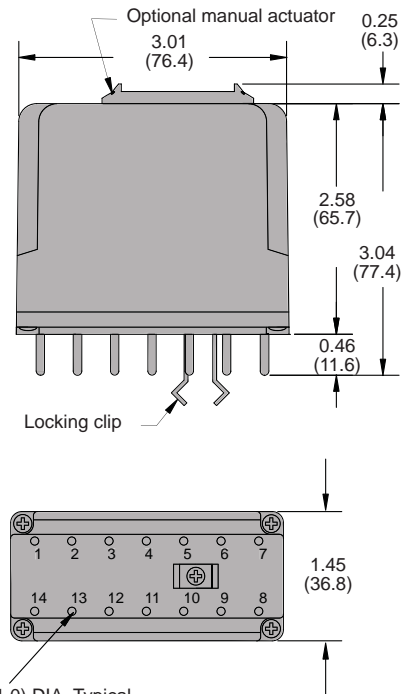

.10 x .43 (2.5 x 11.0) DIA. Typical of all pin dimensions

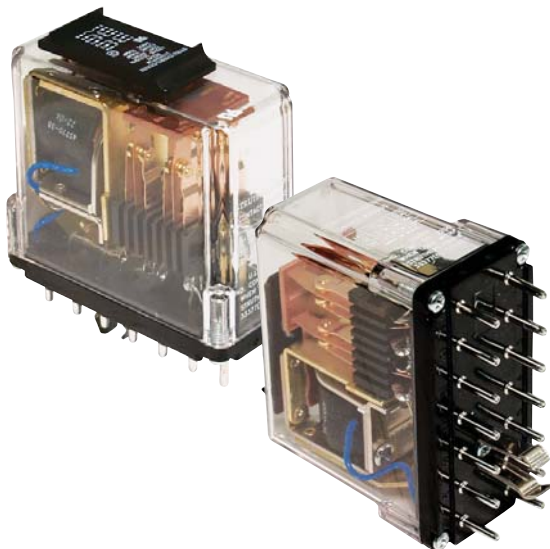

General Purpose Relays

219 Wire Diagram (Top View) 12-Pin

219ABX
(SPST-N.O. + DPDT)

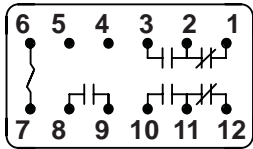

219ABA
(DPDT+SP-NO+1P-NC)

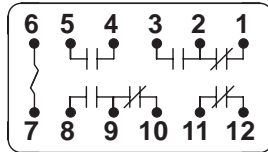

219BBX
(DPDT+2P- N.O.)

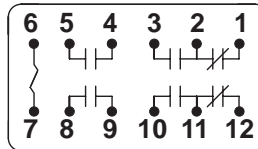

219BXB
(DPDT+2P- N.O.)

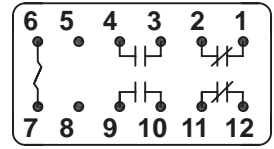

219XBX
(DPDT)

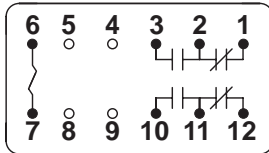

219XCX
(3PDT)

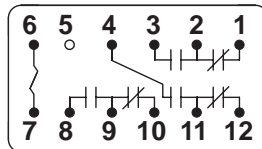

Many additional contact combinations and wiring schematics are available. Contact sales with requirements.

219 Wire Diagram (Top View) 14-Pin

219BXD
(2P-NO+4P-NC)

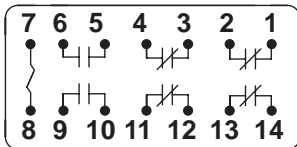

219CXC
(3P-NO+3P-NC)

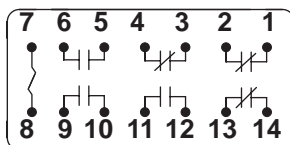

219DXB
(4P-NO+2P-NC)

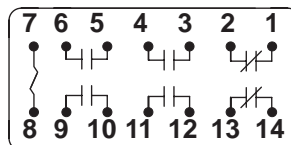

219EXA
(5P-NO+1P-NC)

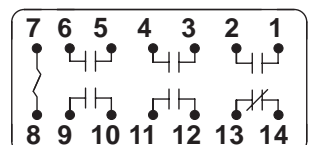

219FXX
(6P-NO)

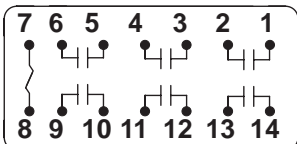

219KXX
(3PST-DM)

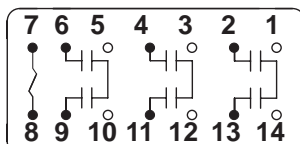

219XDX
(4PDT)

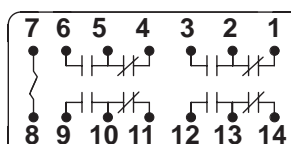

219XJX
(DPDT-DM/DB)

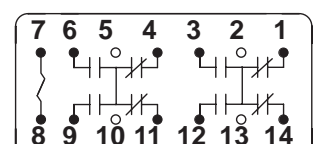

UL LISTED when used with mating sockets
27390 for 12 pin or 33377 for 14 pin